

**THE FUTURE OF  
COMMERCIAL  
VINYL FENCING  
IS HERE TODAY...**

**Meets ASTM F964-09  
Certification At All Times**

**26 Styles Available  
For Immediate Shipment**

**Miami-Dade  
75MPH Certified  
Up to 8' High**

**Fully Assembled 8' Wide  
Panels Standard**

**Mix 'n' Match™ Colors**

**100% Pure Virgin  
Vinyl for Structural  
Integrity and Color  
Consistency**



***Illusions*®  
Vinyl Fence**



# PRIVACY



STANDARD 3' TO 8' HIGH PANELS • ALL PRE-ASSEMBLED • 8' WIDE FOR EASIER INSTALLATION



STANDARD 8'  
WIDE SECTIONS  
GREATLY  
DECREASE  
INSTALL TIME  
TO SAVE BIG \$\$\$!

V3215D-6WGLWT

Restaurants, Parking Lots

## Security and Beauty All In One

Illusions Vinyl Fence is compliant with ASTM F964-09, which is considered the "end all, beat all" testing specification for Vinyl fence. The purpose of this specification is to establish a recognized standard of quality for exterior Vinyl profiles for use in assembling agricultural, commercial, and residential fencing and railing.

100% Pure Virgin Vinyl Illusions Fences are manufactured to the highest testing standards in the world. Created to maintain their structural integrity and color retention over years and years of use. This rigorous testing has made Illusions a perfect fit for Landscape Architects and Fence Contractors for all commercial fence applications.



V300-6 w/French Gothic Caps

# PRIVACY



## V300 Series



V300-8

## V3700 SERIES



V3707-6BWB w/Ball Caps

## V3215 Series



V3215DS-6BGWLW  
w/Alt. Gothic/Ball Caps

## Rackable Up To 16"



V300-6GW w/ Coachman Caps

## Majestic™ 8" x 8" Posts



Gray Majestic™ Post w/ Custom  
White New England/Palace Solar Cap



VBF300-6BW

Fire Departments, Colleges

## Mix 'n' Match™ Curves & Colors

Illusions® Vinyl Fence Mix 'n' Match™ Curves & Colors System isn't just a clever marketing tool dreamed up by ad execs to sell more fences. It provides a real life, project by project solution to compliment the property or structures of any given installation. Notice in the above photo how the arches of the VBF300-6BW fence perfectly compliment the arched windows of the building. Then notice how the white rails and posts with beige panels match the framing around the windows and doors.

## CURVES & COLORS ALSO AVAILABLE IN ALL STYLES

### STANDARD STYLES

All styles available in Mix 'n' Match™ color variations of White, Beige, Gray and Eastern Green\*

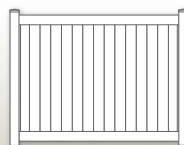

V300

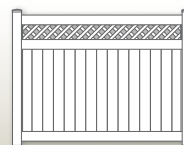

V3215D

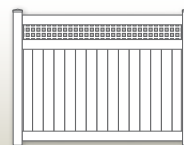

V3215SQ

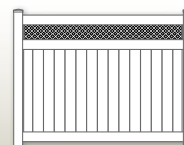

V3215DS

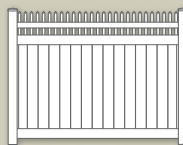

V3700

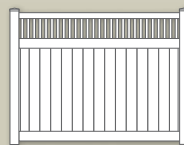

V3701

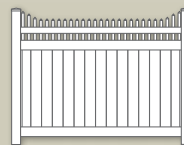

V3706

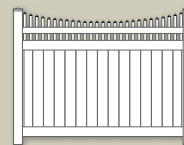

V3707

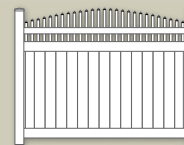

V3708

\*Eastern Green only available in lattice



# SEMI-PRIVACY



### AVAILABLE STYLES

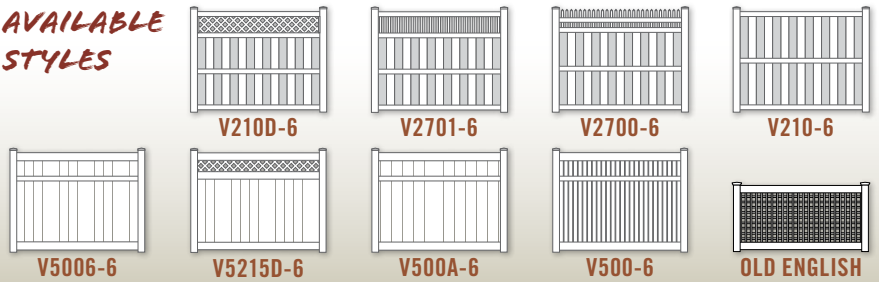

# CONTEMPORARY PICKET



The Good Neighbor  
Thru-Rail Fence



METAL  
U-CHANNEL  
STANDARD IN  
BOTTOM RAIL  
ABOVE 5' HIGH

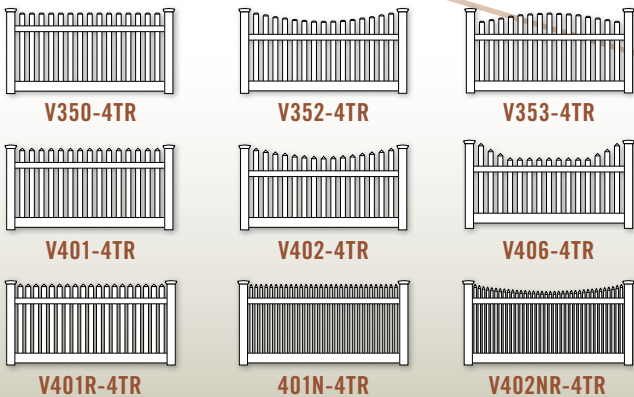

## Simple, Attractive, Timeless

100% Pure Virgin Vinyl Illusions® Contemporary Picket with its "good neighbor" style 3" x 7/8" spaced picket, is the perfect fit for apartment complexes, restaurants, catering halls, and any other application calling for a spaced picket fence for a beautiful "good neighbor" approach.



# CLASSIC VICTORIAN PICKET



V707-4BW

**Classic Victorian Fence** - 1-1/2" x 1-1/2" pickets are the feature of this extremely popular fence style. Based on the look of red cedar picket fences, this is a very attractive "good neighbor" style that is perfect for road facing commercial properties.



V700-4



Apartment Complex Entryway based on V700-4 with D-Rail Sweep

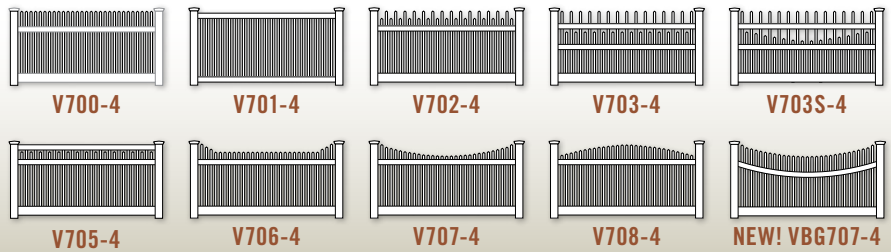

# POST & RAIL

## Animal Friendly

Simply the highest quality Post & Rail available in the market today. Available Posts: 5" x 5" (.140), 5" x 5" Heavy (.250) Wall, and Majestic 8" x 8" Heavy (.250) Wall.



3-RAIL IN BEIGE

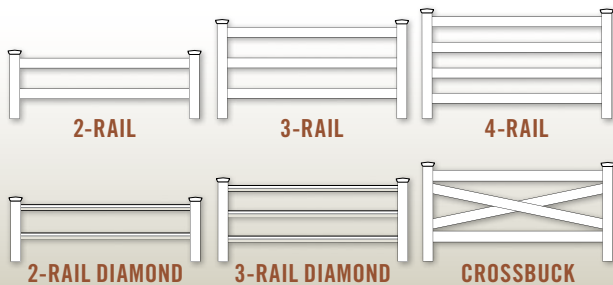

NO LEAD IN ANY ILLUSIONS® PRODUCTS. ANIMAL AND CHILD SAFE.



CROSSBUCK

Businesses

## Safety and Quality First

Illusions® Post & Rail Vinyl Fence contains only premium quality 100% Pure Virgin Vinyl with no hidden fillers that may contain lead or other additives to harm horses or other animals. It has passed all ASTM D4226 Tests for rigidity. The quality simply speaks for itself.



# GATES



VDG3701-56 Drive Gate Shown with 8" x 8" Majestic™ Posts, Extra Strong Hinges (ESH), and 48" Drop Rods (DRAS48).

**EXTRA STRONG HINGE**

**Uni-Weld Gates** - Illusions® Uni-Weld™ Gates and Double-Drive Gates are designed to perfectly match all of our fence styles. We also have curved or scalloped accent gates available to create the perfect entrance way for every application.



VWG300-BG

VWG300-BW

VWG3215D

VWG3700

VWG3707

**UNI-WELD CONSTRUCTION™**



VWG1



VBG10

VWG707

VWG700

VBG12

VBG11

VBG2

VBG3

VBG4

VBG5

VBG6

VBG8

**THE BEST IN THE BUSINESS!**

# ACCESSORIES



EXTERNAL FLAT



NEW ENGLAND



GOthic



BALL



COACHMAN



TEARDROP



PALACE SOLAR

## Picket Top Styles



**DOG EAR**



**POINTED**

1. 7/8" x 6" with Dog Ear Cap
2. 7/8" x 1.5" with Pointed Cap
3. 7/8" x 3" with Dog Ear Cap
4. 7/8" x 3" with Pointed Cap
5. 1-1/2" x 1-1/2" w/ Pyramid Cap



All *Illusions*® Gate Hardware is custom designed to our specifications and manufactured using only the highest quality materials that are held to the same rigorous standards we use for all of our products. Many of our products are available in both black and white. Always use a Vinyl Gate Stopper (VGS) and two sets of Drop Rods (DRAS) on double drive gates.



IESH

VGS

VHDL

MLS-BK

CPH55

V21LLP

V21SS

HLSS

DRAS

HLSS-WT

CPH55S-WT

V21SS-WT

ML-WT

DRAS-WT

CSB-12SS

CPH55S

THAHD

THSL

# SPECIFICATIONS



## WHAT IS ASTM F964-09?

### Scope

ASTM F964-09 is considered the “end all, beat all” testing specification for Vinyl fence. The purpose of this specification is to establish a recognized standard of quality for exterior Vinyl profiles for use in assembling agricultural, commercial, and residential fencing and railing. This specification covers **Illusions® Vinyl Fence** sections and the EverStrong Profiles used to fabricate them.

### Materials

**Illusions® Vinyl Fence** Products are manufactured using Rigid Poly Vinyl Chloride (PVC) compounds for exterior-profile extrusions that meet the requirements of ASTM Specification D4216.

### Manufacture

**Illusions® Vinyl Fence** Products are manufactured to meet cell Class 1–32333–3 as defined in Specification D4216. **Illusions®** compounds have higher cell classification because one or more properties are superior to those used in standard acceptable compounds.

**Color/Consistency Testing** – The PVC compound in extruded section shall maintain uniform color and be free of any visual surface or structural changes, such as peeling, chipping, cracking, flaking, or pitting after weathering at intervals of six months and one year for white and for six months, one year, and two years for all other colors in hot, dry climate such as Phoenix, AZ; a hot humid climate, such as Miami, FL; and a temperate northern climate, when tested in accordance with ASTM Performance Weathering Requirements (TABLE 1).

**Weathering Testing** – The PVC compound shall have a minimum impact resistance of 0.6 in.-lb/mil (2670 J/m) after weathering six months and one year in a hot, dry climate such as Phoenix, AZ; a hot, humid climate, such as Miami, FL; and a temperate northern climate, when tested in accordance with ASTM Performance Weathering Requirements. The PVC compound shall have successfully met the weathering requirements prescribed for six months at each climatic testing site prior to use in production of exterior-profile extrusions, when tested in accordance with ASTM Performance Weathering Requirements (TABLE 1).

## ASTM Specifications Met

- D256** – To determine Izod impact properties
- D618** – Practice for Conditioning Plastics for Testing
- D635** – Test Method for Rate of Burning and/or Extent and Time of Burning of Plastics in a Horizontal Position
- D638** – To determine tensile properties
- D648** – To determine heat distortion temperature
- D696** – Test Method for Coefficient of Linear Thermal Expansion of Plastics Between 030°C and 30°C with a Vitreous Silica Dilatometer
- D790** – To determine flexural properties
- D792** – To determine specific gravity
- D883** – Terminology Relating to Plastics
- D1435** – Practice for Outdoor Weathering of Plastics
- D1600** Terminology for Abbreviated Terms Relating to Plastics
- D1784** – Specification for Rigid Poly (Vinyl Chloride) (PVC) Compounds and Chlorinated Poly (Vinyl Chloride) (CPVC) Compounds
- D1898** – Practice for Sampling of Plastics
- D2240** – To determine Shore hardness values
- D2244** – Practice for Calculation of Color Tolerances and Color Differences from Instrumentally Measured Color Coordinates
- D2565** – Practice for Xenon-Arc Exposure of Plastics Intended for Outdoor Applications
- D4216** – Material Class Number 1-32333-3. To establish Cell Classification of PVC material. Illusions compounds have higher cell classification because one or more properties are superior to those used in standard acceptable compounds
- D4226** – Test Methods for Impact Resistance of Rigid Poly-(Vinyl Chloride) (PVC) Building Products
- D4726** – Specification for Rigid Poly(Vinyl Chloride)

(PVC) Exterior-Profile Extrusions Used for Assembled Windows and Doors

**E-84-04** – Used to determine the flame spread value of PVC material; **Illusions®** burn rate is significantly lower than allowed value

## Quality Assurance

**Illusions® Vinyl Fence** Products are run through a series of dimensional and color tests that are performed at least every two hours. Testing includes; flattening, extrusion quality, impact resistance, warp, color comparison with standard color samples, capstock thickness, and bond testing. All will be done at the startup of a production and once per shift thereafter with a minimum of two tests per 24 hours of production.

**TABLE 1 - Required Exposures for PVC Extrusions - In Process**

Color of PVC Extrusions	Exposure Climate	Required Exposure Times, Months*
White	hot, dry (Phoenix, AZ)	6 and 12
	hot, humid (Miami, FL)	6 and 12
	northern temperate	6 and 12
Any other color	hot, dry (Phoenix, AZ)	6, 12 and 24
	hot, humid (Miami, FL)	6, 12 and 24
	northern temperate	6, 12 and 24

\*It is recommended that separate specimens be used for each exposure time.

THESE ARE THE RESULTS FROM AN ACCELERATED WEATHER TESTING CHAMBER IN LABORATORY CONDITIONS

## The *Illusions®* Vinyl Fence Advantage

This test is run according to ASTM Standard G-155, Cycle #1. All *Illusions®* Vinyl Fence Product is guaranteed to be made from 100% Pure Virgin Vinyl and assembled according to ASTM F964. Please note the difference in color retention and be assured, *Illusions®* Vinyl Fence will have uniformed color and be free of any visual surface or structural changes such as: peeling, chipping, cracking, flaking, or pitting after weathering.

Be assured! Insist on *Illusions®* Vinyl Fence Products.

**Competitor:**  
450 Hrs.  
(4-5 Years)

**Illusions®:**  
1000 Hrs.  
(10-11 Years)

NFA Weather Test Illusions ©2008



# 75MPH WIND KITS™



**What is the Miami-Dade County High Velocity Hurricane Zone Wind Certification and why is it important for commercial applications?** - Due to intense hurricanes, the building code specifications for Miami-Dade County, Florida are considered to be the most stringent in the nation. This certification provides an extreme competitive advantage that allows for safer installation, more customer confidence, increased closing ratios and decreased repair costs.



## HEAVY DUTY POSTS THE STRENGTH BEHIND THE SYSTEM



### Majestic™ 8" x 8" and 5" x 5" Heavy Duty Posts

At a whopping .250" wall thickness, the Illusions® 75MPH Wind Adaptor Kit's strength is rooted in the structural integrity of the Illusions® 100% Pure Virgin Vinyl Heavy Duty Posts. With the consistent high quality structural properties of pure virgin vinyl as the basic building block, it's no surprise that Illusions® products easily passed the rigorous testing for the Miami-Dade County Hurricane Zone Certification.

## Illusions® 75MPH Wind Adaptor Kit Patent Pending

Will it hold up to an F5 tornado? Probably not. But in order to be certified, it had to sustain gusts up to 130 MPH for as long as 30-40 seconds. The Miami-Dade 75 MPH certification states that when properly installed, approved styles of Illusions® fencing can withstand sustained 75 MPH winds.

### The Most Available 75 MPH Wind Certified Styles in the World

With 26 Styles available for immediate shipment, Illusions® Vinyl Fence has the most Miami-Dade County High Velocity Hurricane Zone Certified styles of vinyl fence available in the world. All of which are 8' wide panels to speed up installation time. Illusions® is also the only brand in the world that has 75MPH Certified 8' high Vinyl fence sections. Imagine the 8' high applications for pure virgin vinyl products in multiple colors. The variations are endless and the strength and security unmatched.

## QuickShip®

### 26 Styles

With the 75MPH Wind Adaptor Kit properly installed, 26 Styles of Illusions® Vinyl Fences have been independently tested and certified to withstand winds up to 75 miles per hour. This includes our complete line of Privacy (Series V300, V3215, and V3700) up to 8' high. Spaced Picket Styles (Series V400, V352, V700) up to 4' high. **All styles are available for immediate shipment.**

### 75 MPH WIND ILLUSIONS Vinyl FENCE CERTIFIED ADAPTOR KITS

Item No.	Description
V75MPH-1	Privacy V300, V3215 Series 6'H 75 MPH Kit
V75MPH-2	Privacy 7' & 8'H 75 MPH Kit
V75MPH-3	Spaced Picket to 4'H 75 MPH Kit
V75MPH-4	Privacy 3700 Series 6'H 75 MPH Kit

**QUICKSHIP®  
ORDER BY  
5PM FOR  
NEXT DAY  
SHIPMENT! ↗**



# 75MPH WIND KITS™



**MIAMI-DADE COUNTY**  
BUILDING CODE COMPLIANCE OFFICE (BCCO)  
PRODUCT CONTROL DIVISION  
**NOTICE OF ACCEPTANCE (NOA)**

MIAMI-DADE COUNTY, FLORIDA  
METRO-DADE PLACE BUILDING  
140 WEST FLAGLER STREET, SUITE 1603  
MIAMI, FLORIDA 33139-3563  
(305) 375-2901 FAX (305) 372-6339  
[www.miamidade.gov/buildingcode](http://www.miamidade.gov/buildingcode)

Eastern Wholesale Fence Company, Inc.  
274 Middle Island Rd.  
Medford, NY 11763

**SCOPE:**  
This NOA is being issued under the applicable rules and regulations governing the use of construction materials. The documentation submitted has been reviewed by Miami-Dade County Product Control Division and accepted by the Authority Having Jurisdiction (AHJ). This product or material falls to the right where allowed by the Authority Having Jurisdiction (AHJ) (in areas other than Miami-Dade County) reserve the right to have this product or material tested for quality assurance purposes. If this product or material falls to the right of this NOA shall not be valid after the expiration date stated below. The Miami-Dade County Product Control Division (in Miami-Dade County) and/or the AHJ (in areas other than Miami-Dade County) may immediately revoke, modify, or suspend the use of such product or material within their jurisdiction. BORA perform in the accepted manner, the manufacturer will incur the expense of material building code. This product is approved as described herein, and has been designed to comply with the Florida Building Code, including the High Velocity Hurricane Zone.

**DESCRIPTION:** Illusions Vinyl Fence  
**APPROVAL DOCUMENT:** Drawing titled "Illusions Fence" sheets 1 through 18, dated from 10/07/09 and 09/08/09, prepared by Eastern Wholesale Fence, Inc., signed and sealed by Fred S. Cardwell, P.E., hearing the Miami-Dade County Product Control approval stamp with the Notice of Acceptance number and approval date by the Miami-Dade County Product Control Division.

**MISSILE IMPACT RATING:** None

Eastern Wholesale Fence Company, Inc.

**NOTICE OF ACCEPTANCE: EVIDENCE SHEETS**

- A. DRAWINGS**  
1. Drawing titled "Illusions Fence" sheets 1 through 18, dated from 10/07/09 and 09/08/09, prepared by Eastern Wholesale Fence, Inc., signed and sealed by Fred S. Cardwell, P.E.
- B. TESTS**  
1. Test reports on 1) Dynamic Wind Load Testing, 2) Static Load Post Testing, along with marked-up drawings and installation diagram of 4, 6ft and 8 ft high vinyl Illusions fence systems, prepared by Architectural Testing, Inc., Test Report No. 87954.01-119-18, dated 05/06/09, with Revision 4 dated 09/16/09, signed and sealed by Joseph A. Reed, P.E.  
2. Test reports on 1) Artificial Outdoor Exposure per ASTM G 155-05a, by Joseph A. Reed, P.E., 2) Tensile Testing per ASTM D 638-03, 3) Rate of Burning per ASTM D 2843-09, 4) Smoke Density per ASTM 1929-96, 5) Self Ignition temperature and installation diagram of vinyl Illusions fence systems, prepared by Architectural Testing, Inc., Report No. 87954.03-119-18, dated 08/18/09, signed and sealed by Joseph A. Reed, P.E.
- C. CALCULATIONS**  
1. Fence foundation calculations, dated 10/16/09, prepared, signed and sealed by Fred S. Cardwell, P.E.
- D. QUALITY ASSURANCE**  
Miami-Dade Building Code Compliance Office (BCCO).

## Illusions Vinyl Fence

### 75 MPH Wind Kit Installation Instructions

#### Items Needed to Complete Installation:

- Selected Illusions Vinyl Fence Style
- Selected Illusions Vinyl Post (VH55 \_\_\_ or VH88 \_\_\_)
- Adaptor Kit
- Concrete Post Mix
- Post Cap Style
- Tools
- Phillips Head Power Screw Driver
- 1/8" Drill Bit
- Post Hole Digger
- Level and String Line
- Temping Bar
- Illusions Vinyl Cap Glue

Meets Dade County 75MPH Wind Load Independent Tests.  
8' Maximum Width x 8' Maximum Height.

This installation guide is a recommendation for installing Illusions® Style Fences. For certification of installation to meet 75MPH Wind Load Properties, Always check your local building codes before starting a project and for determining the acceptable installation practices of your area. Read assembly instructions completely before beginning construction. Always wear protective goggles and gloves when installing a vinyl fence.

V75MPH-1 Includes (per kit, per section)	V75MPH-2 Includes (per kit, per section)	V75MPH-3 Includes (per kit, per section)	V75MPH-4 Includes (per kit, per section)
3/4" Screws x 2 (Concrete)	3/4" Screws x 4 (Concrete)	3/4" Screws x 2 (Concrete)	3/4" Screws x 2 (Concrete)
3/4" Screws x 2 (Concrete)	3/4" Screws x 4 (Concrete)	3/4" Screws x 2 (Concrete)	3/4" Screws x 2 (Concrete)
3/4" Screws x 2 (Concrete)	3/4" Screws x 4 (Concrete)	3/4" Screws x 2 (Concrete)	3/4" Screws x 2 (Concrete)

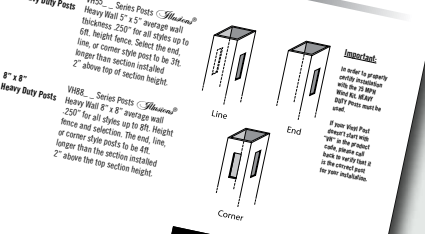
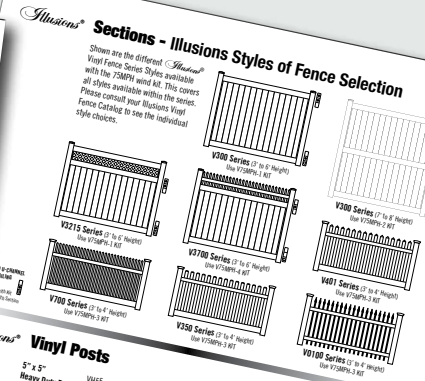

**IMPORTANT NOTE:**  
Installer must comply with local code officials for compliance to building code requirements.

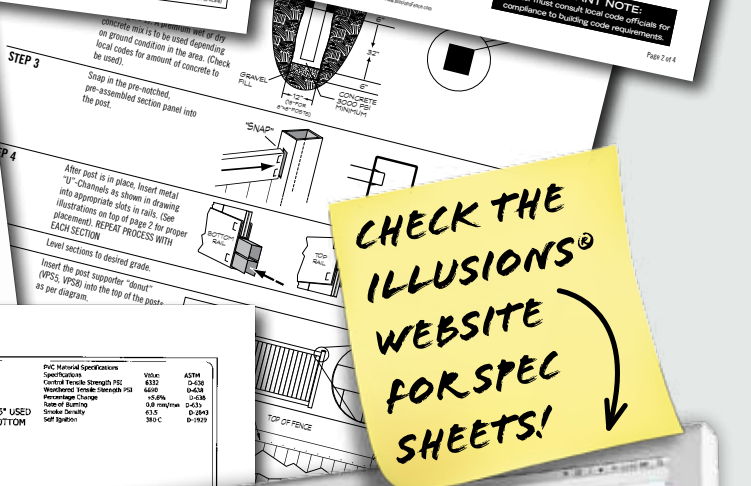

**CHECK THE ILLUSIONS® WEBSITE FOR SPEC SHEETS!**

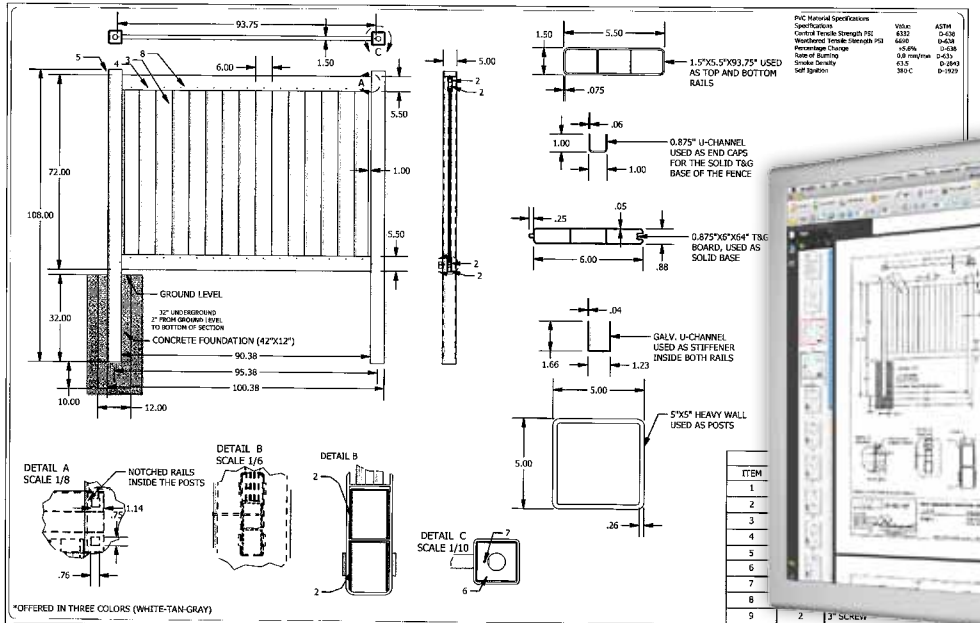

MIAMI-DADE COUNTY 75MPH WIND LOAD FOR HIGH VELOCITY HURRICANE ZONE  
STYLE# V300-6 DESCRIPTION Vinyl 4" High Tongue & Groove Solid Panel  
Eastern Wholesale Fence, Inc. - 274 Middle Island Rd. Medford, NY 11763  
www.IllusionsFence.com

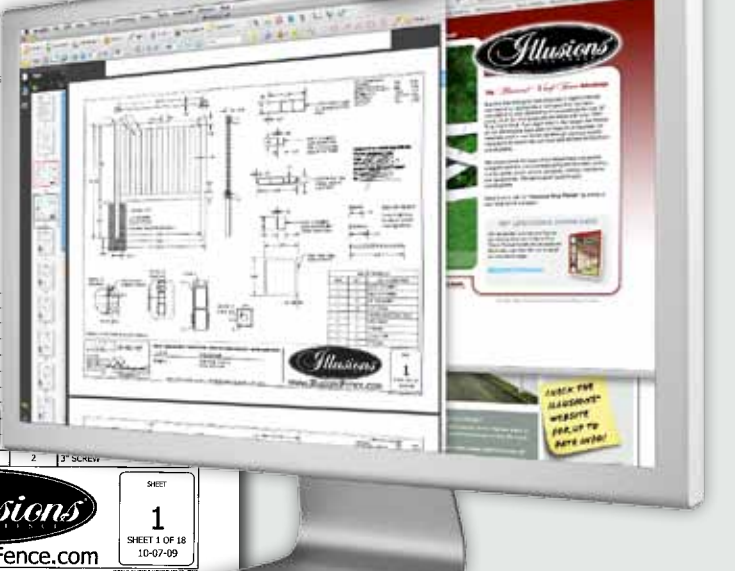



# WHY ILLUSIONS?



**What is F964-09?** - F964-09 is the ASTM International standard specification for rigid poly vinyl-chloride (PVC) exterior profiles used for fencing and railing. This specification establishes requirements for the material properties and physical properties, including dimensional tolerances, extrusion quality, and weatherability, of rigid poly vinyl-chloride (PVC) exterior profiles used for agricultural, commercial, residential fencing and railing.



School Playgrounds, Parks & Recreation

V300-8

## Why Illusions?

With the highest building code compliances in the nation, the largest Miami-Dade Hurricane Zone style selection in the market today, 26 styles available for immediate shipment, almost unlimited Mix 'n' Match™ possibilities with every style, and unparalleled speed and service, it's no wonder that Illusions Vinyl Fence is the first choice of Landscape Architects and Fence Contractors everywhere.

100% Pure Virgin Vinyl Illusions Fences are manufactured to maintain their structural integrity and color retention over years and years of use. Illusions® will certify that all of our Vinyl fence is manufactured in the USA and is in compliance with applicable Federal, State and local specifications.



V352-4TR



# APPLICATIONS



RAILINGS TOO!

Looking for an ICC-ES AC174 certified railing system to match your Illusions® Vinyl Fence installation? Illusions® Vinyl Railing System™ is a complete line of fully 100% Pure Virgin Vinyl, ICC-ES AC174 certified, pre-assembled section vinyl railings. All made to perfectly match the colors of our Illusions® Mix 'n' Match color system. Check out [www.IllusionsVinylRailing.com](http://www.IllusionsVinylRailing.com) for all the most updated information including catalog, instructions, and more.

## ILLUSIONS® VINYL FENCE

### POSSIBLE COMMERCIAL APPLICATIONS

- AIRPORTS
- APARTMENT COMPLEXES
- CEMETERIES
- CORRECTIONAL FACILITIES
- DOG KENNELS
- GOLF COURSES
- GOVERNMENT FACILITIES
- HIGHWAY FENCING
- INDUSTRIAL GATES
- INDUSTRIAL PLANTS
- MINI-STORAGES
- NURSERIES
- OFFICE COMPLEXES
- PARKING LOTS
- PARKS & PLAYGROUNDS



- PERIMETER SECURITY
- PUBLIC WORKS
- RESIDENTIAL
- SECURITY PARTITIONS
- SPORTS FACILITIES
- SWIMMING POOLS
- ZOOS



26 STYLES  
75 MPH  
CERTIFIED\*  
IN COLORS!  
\*WITH ILLUSIONS 75MPH WIND ADAPTOR KIT

## Imagine the Possible Applications

A Complete line of accessories • Millions of variations using the Mix 'n' Match™ Curves & Colors System • Seven styles of unique post caps to choose from • Three different post variations (5" x 5" Standard, 5" x 5" Heavy Duty, and Majestic™ 8" x 8") • Illusions® Hardware available in both black and white • Uni-Weld™ Matching Accent Gates Finding a unique and attractive fence style for any application should be both easy and fun.

THE ONLY FENCE IN AMERICA THAT HAS ALL 8' WIDE SECTIONS UP TO 8' HIGH THAT PASSED THE MIAMI-DADE HURRICANE ZONE WIND TESTING (WITH ILLUSIONS® 75MPH WIND ADAPTOR KIT - PATENT PENDING).



V3708-6 w/ VWG3708-46 Walk Gate, Custom V3708 Drive Gate with Majestic™ 8" x 8" Posts and Custom Majestic™ Ball Caps



V0402-4



# ILLUSIONS® VINYL FENCE

Shown: Custom Apartment Complex Entryway with Majestic™ 8" x 8" Posts with Ball Caps, 5" x 5" Posts with Ball Caps, and D-Rail Sweep Transition Panels based on the V700-4 Classic Victorian Spaced Picket Fence.

**Illusions® Post Specifications**

Profile Code	Wall Thickness	+/- Tolerance
V559L - 5" x 5" x 9' Standard Line Post	0.1380	0.0100
VH559E - 5" x 5" x 9' Heavy Wall End Post	0.2500	0.0140
V889C - Majestic™ 8" x 8" Heavy Wall Corner Post	0.2500	0.0140

Based on Tolerance

AFTER DOING THE RESEA  
WE'VE DECIDED THAT  
ILLUSIONS® VINYL FEN  
IS HANDS DOWN THE  
BEST CHOICE FOR THE  
MIDLAND COUNTY  
HOSPITAL PROJECT.  
THE 75MPH WIND  
ADAPTOR KIT IS A  
NO BRAINER! WE  
NO PROBLEM GE  
THE BID!!!



**Illusions® Vinyl Fence**  
Just Built Better

Phone: 800.339.3362  
Email: info@illusionsfence.com  
www.illusionsfence.com

274 Middle Island Rd.  
Medford, NY 11763

HERE'S A PIC OF THE  
V3707-6 FROM A PREVIOUS  
PROJECT. THE CUSTOMER  
WAS EXTREMELY HAPPY

LET'S SPEC IN THE  
75MPH WIND  
ADAPTOR KITS ON  
THIS JOB SINCE  
IT BACKS UP TO  
FARM FIELDS.

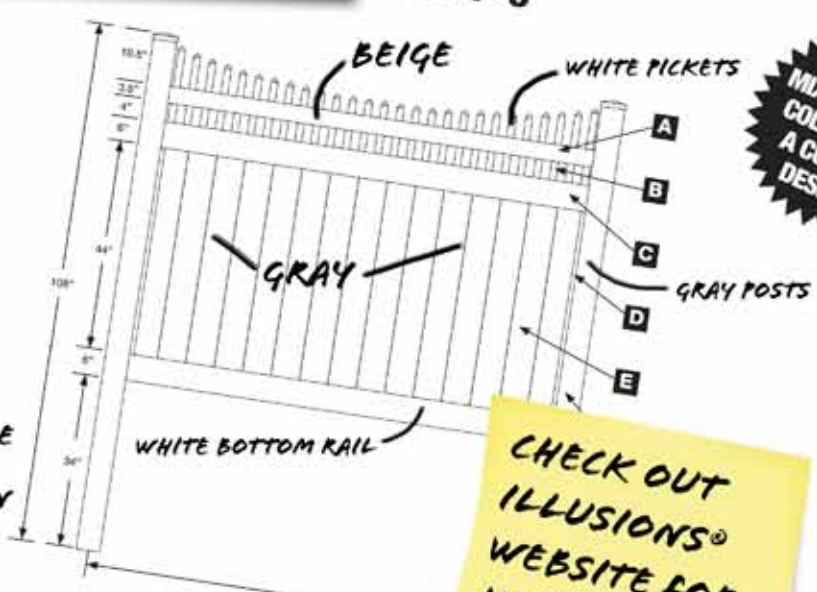

CHECK OUT  
ILLUSIONS®  
WEBSITE FOR  
UP TO DATE  
SPEC SHEETS!

Date: 10/14/09  
Customer: Sample Architectural Firm  
Customer Code: SAM123  
Contact: John D.  
Fax: 555-555-5555  
E-mail: sales@samplefence.com

STYLE #  
**3707-6**

DESCRIPTION  
T&G with Scalloped Classic Victorian Picket Top

**Illusions® Vinyl Fence**  
www.IllusionsFence.com

SHEET 1



ILLUSIONS COMMERCIAL BROCHURE 0110 • ILLUSIONS FENCE ©2010